

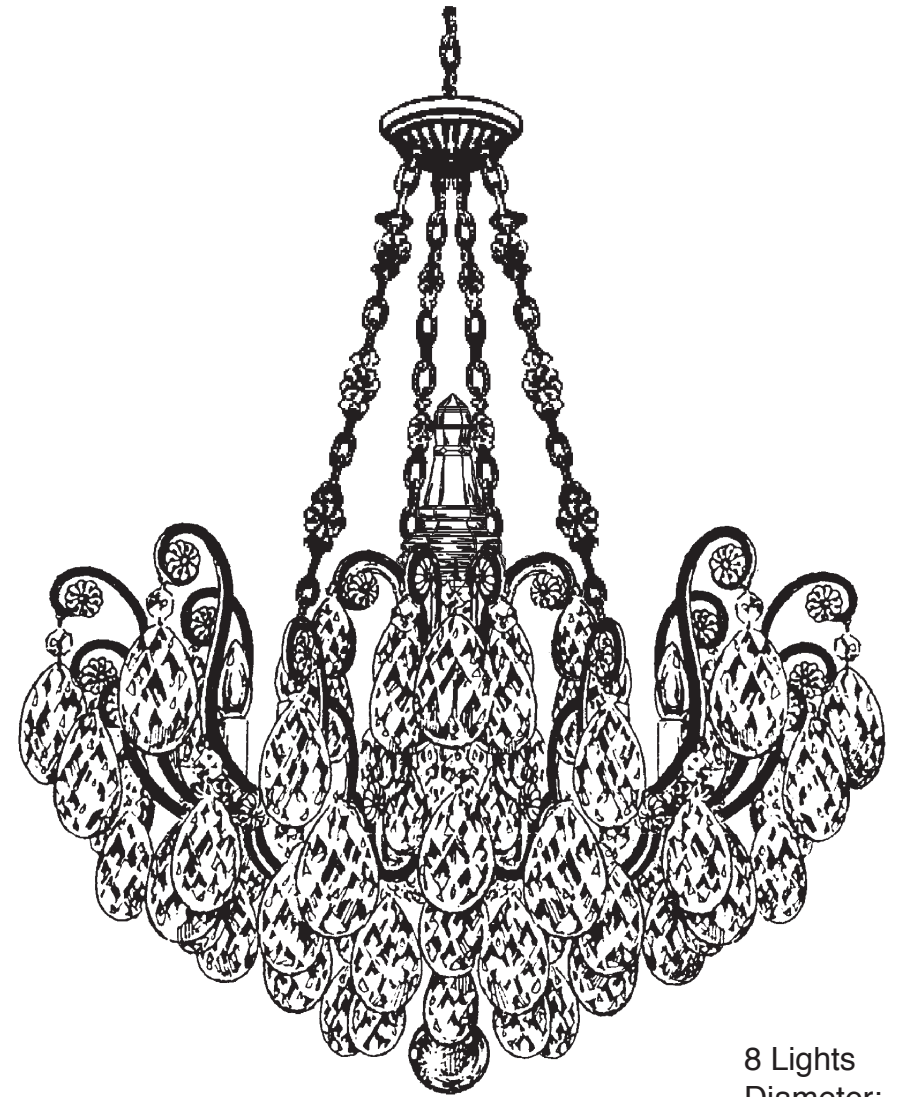

**SCHONBEK®**

RENAISSANCE 3787- \_ \_ \_



**T**HIS DESIGN IS THE PROPRIETARY TRADE DRESS/TRADEMARK OF SWAROVSKI LIGHTING, LTD.

8 Lights  
Diameter: 26-1/2"  
Body Length: 35"  
Hanging Weight: 37 lbs.



**SCHONBEK®**

MAX <u>60</u> W		110-120 V						

SCHONBEK® is a member of the Swarovski group.

All electrical components must be installed by a licensed electrician in accordance with the National Electric Code and the appropriate local electrical codes.

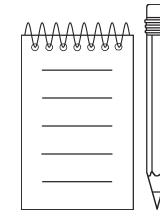
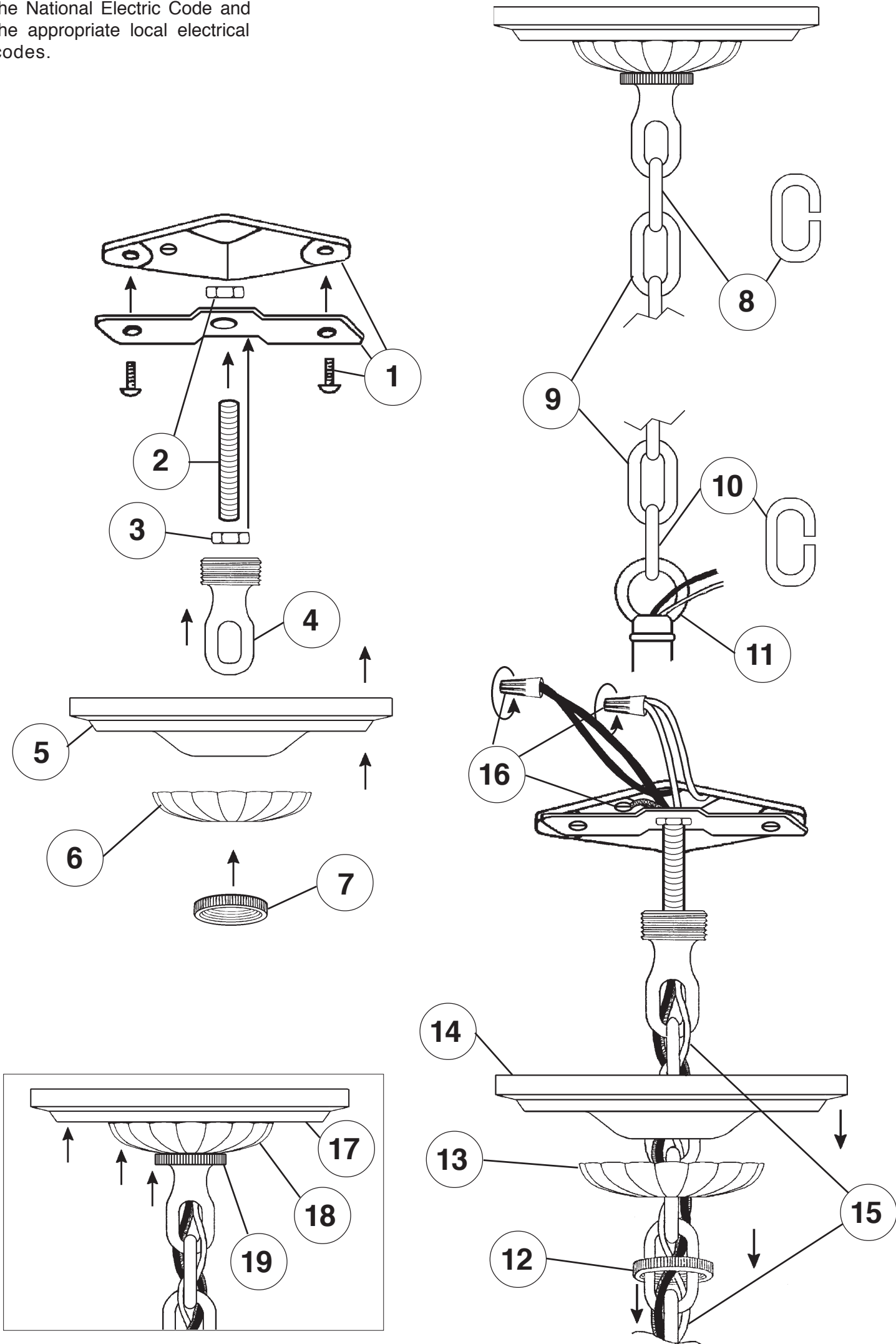

**Crystal Set #3 in Black**

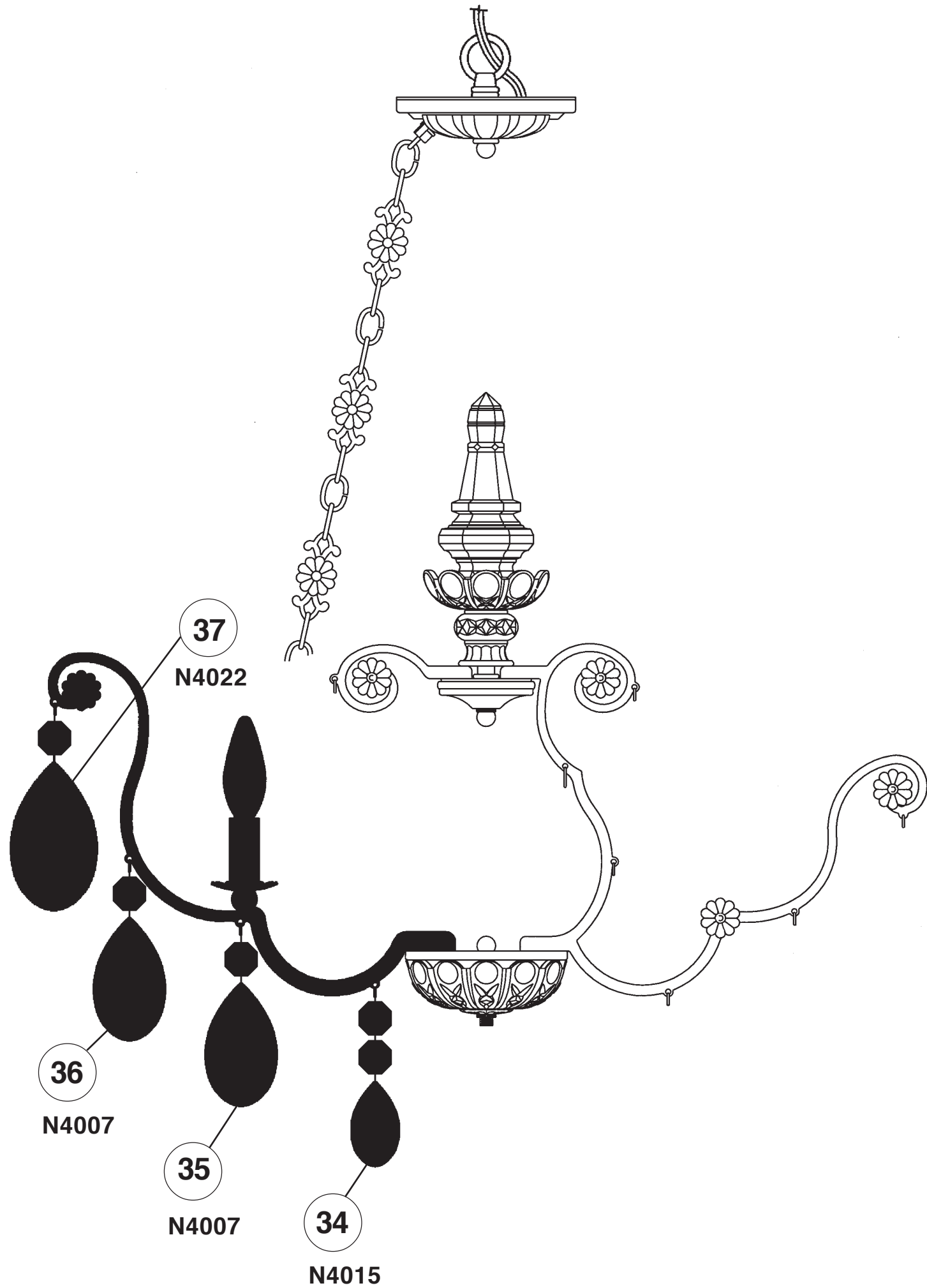

**SET #1**

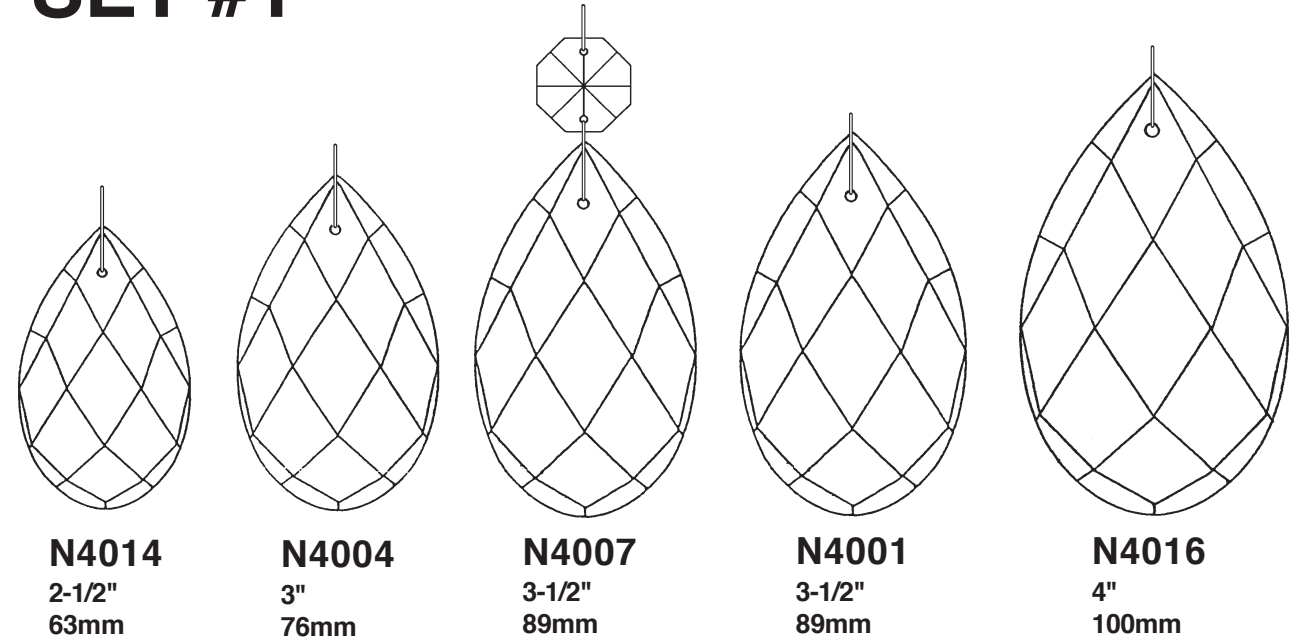

**SET #2**

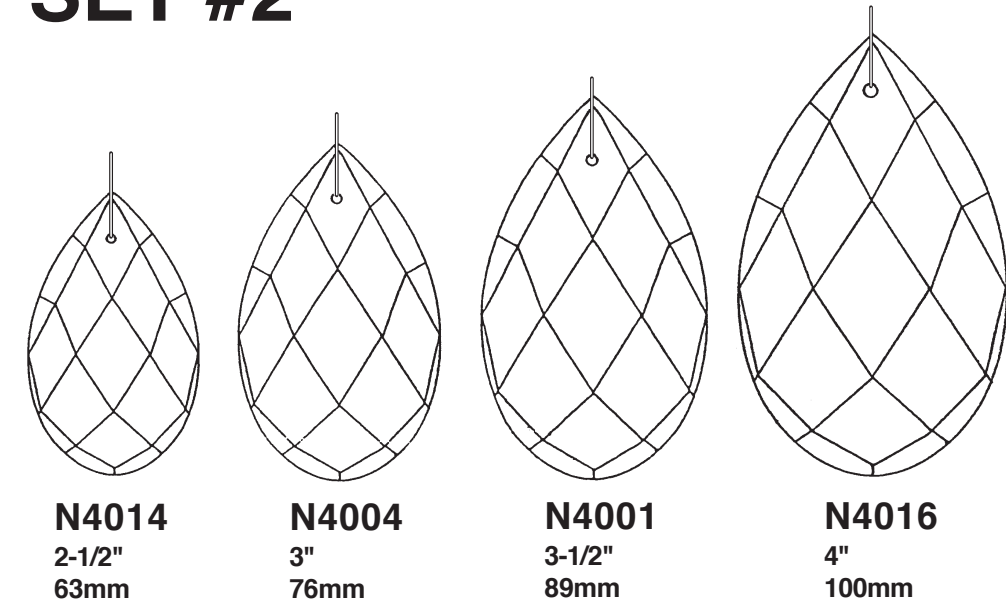

**SET #3**

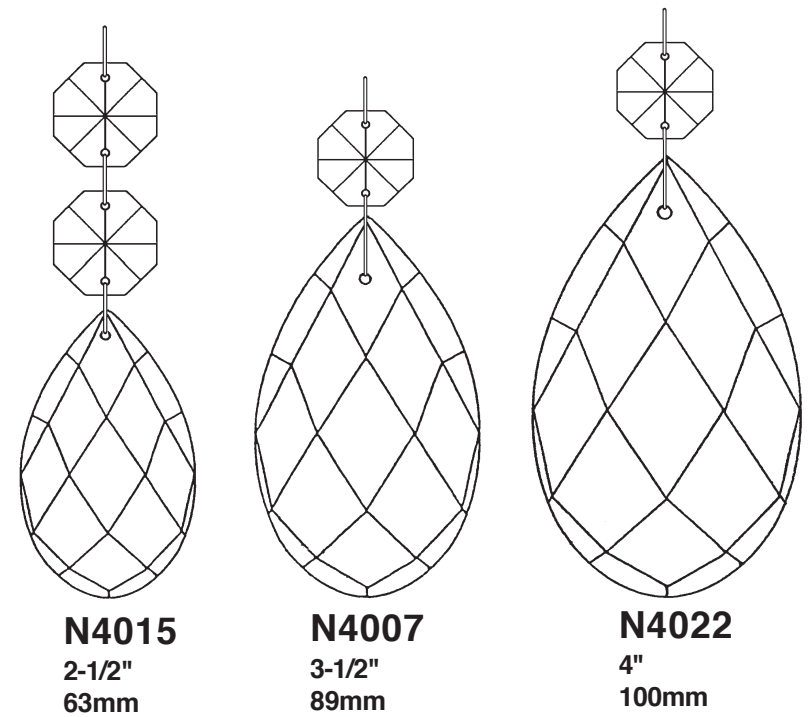

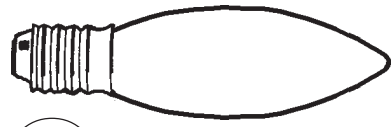

20

You will need 8 - B10  
25 Watts Recommended  
60 Watts Max

Install bulb and be sure  
to test fixture **BEFORE**  
trimming.

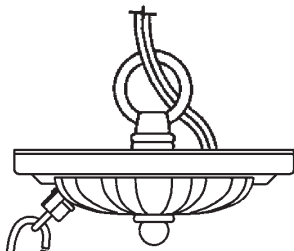

Crystal Set #1 in Black

21

9552/150

24

N4007

23

N4014

22

N4001

29

N4016

28

N4001

27

N4004

25

N439-\*\*

26

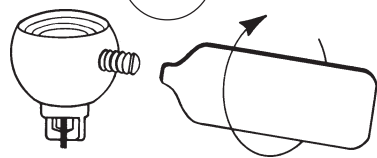

Crystal Set #2 in Black

9302

9419

30

N4014

9319

33

N4016

32

N4001

31

N4004

