

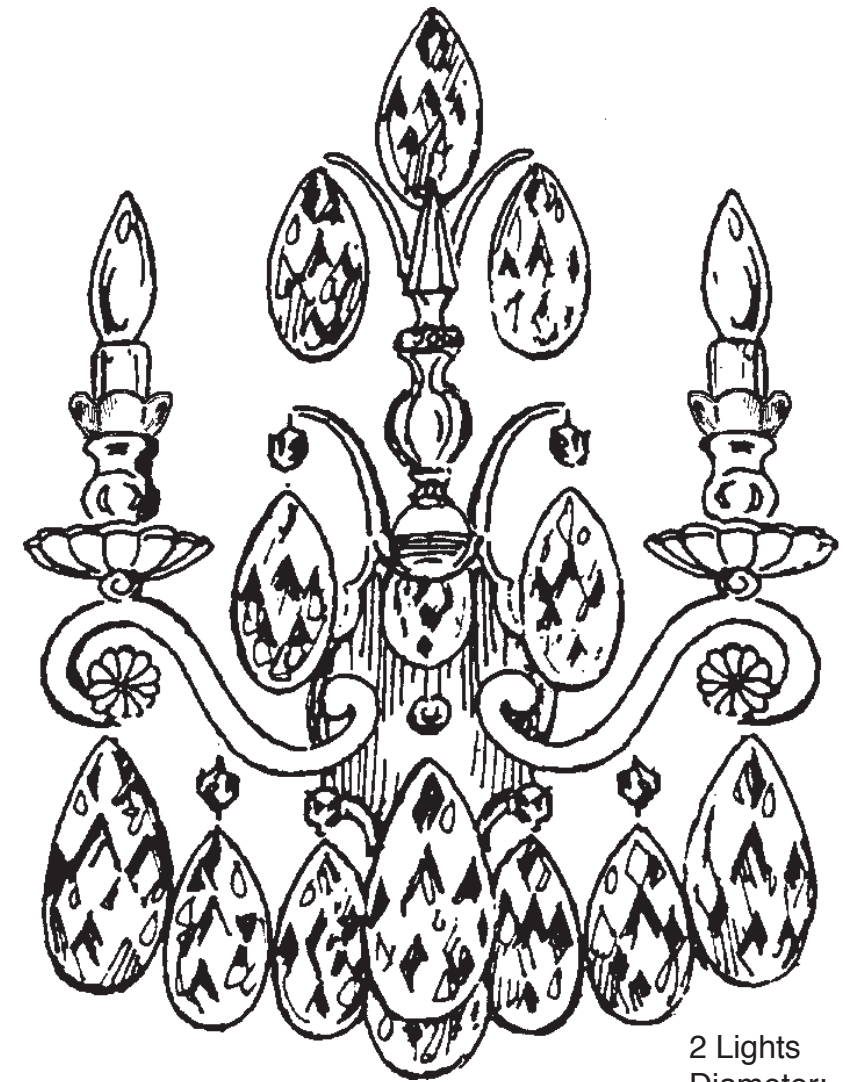

SCHONBEK®

RENAISSANCE 3761- _ _ _



2 Lights
Diameter: 15"
Body Length: 22-1/2"
Extension: 8"
Hanging Weight: 8 lbs.

THIS DESIGN IS THE PROPRIETARY
TRADE DRESS/TRADEMARK OF
SWAROVSKILIGHTING, LTD.



SCHONBEK®

MAX <u>60</u> W		110-120 V						

SCHONBEK® is a member of the Swarovski group.

All electrical components must be installed by a licensed electrician in accordance with the National Electric Code and the appropriate local electrical codes.

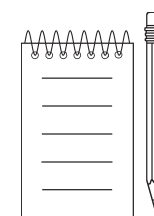
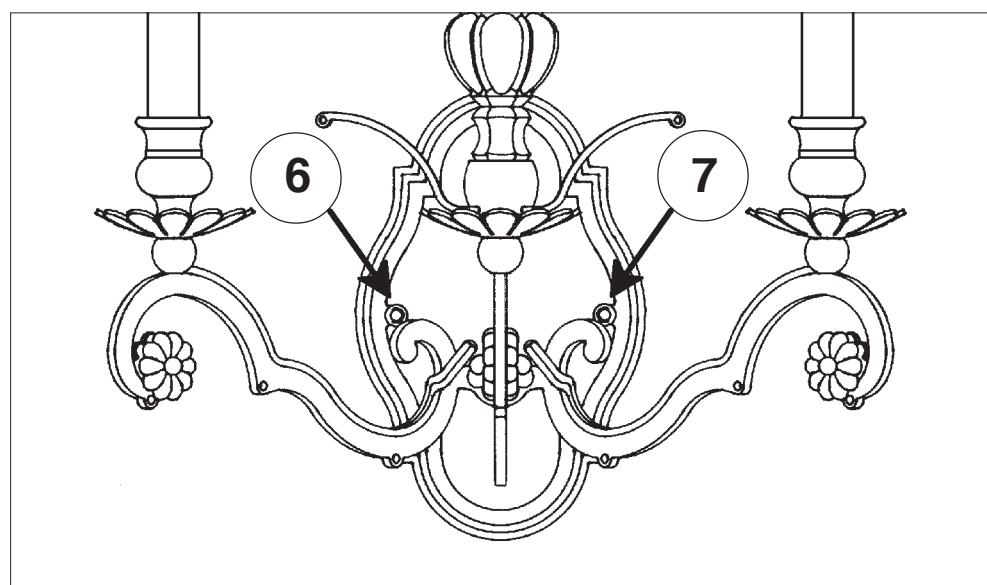
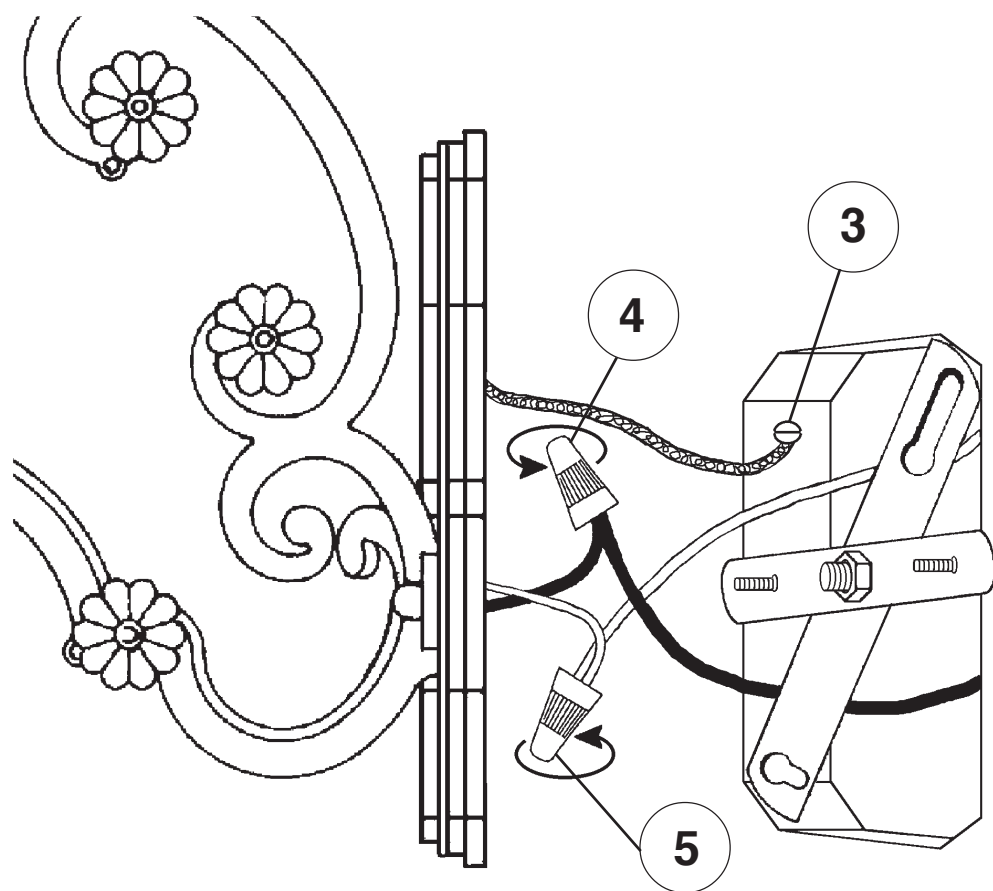
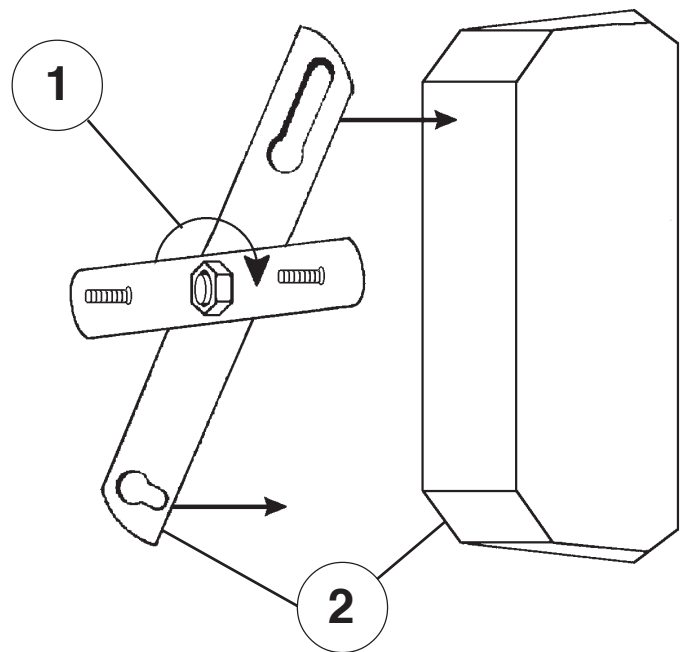

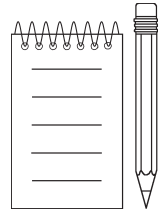

SET #1

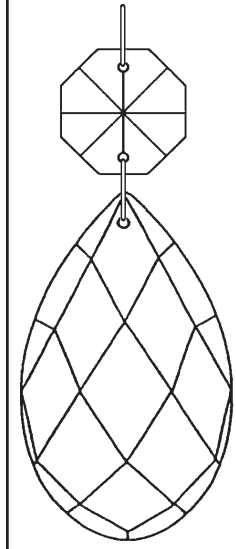

N4003
2-1/2"
63mm

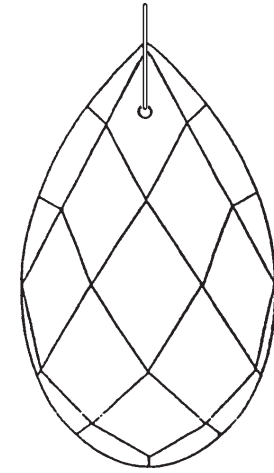

N4004
3"
76mm

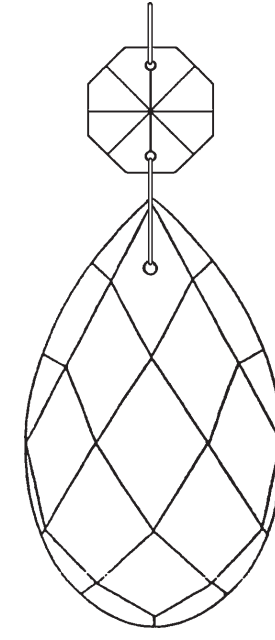

N4000
3"
76mm

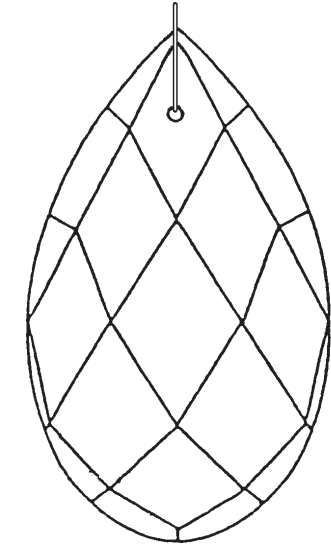

N4001
3-1/2"
89mm

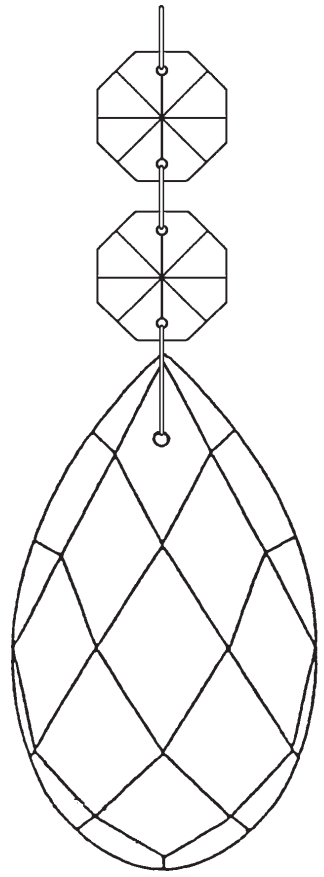

N4002
3-1/2"
89mm

SET #2

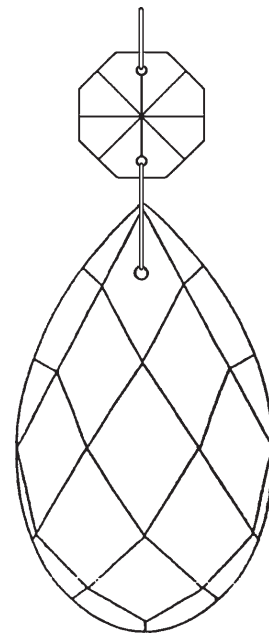

N4000
3"
76mm

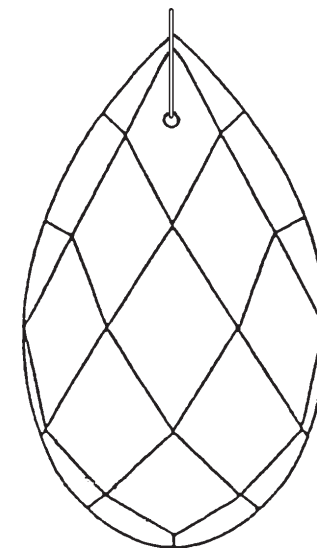

N4001
3-1/2"
89mm

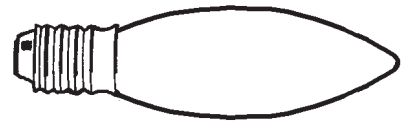

9 2 - B10
60 Watts Max
25 Watts Recommend

Crystal Set #1 in Black

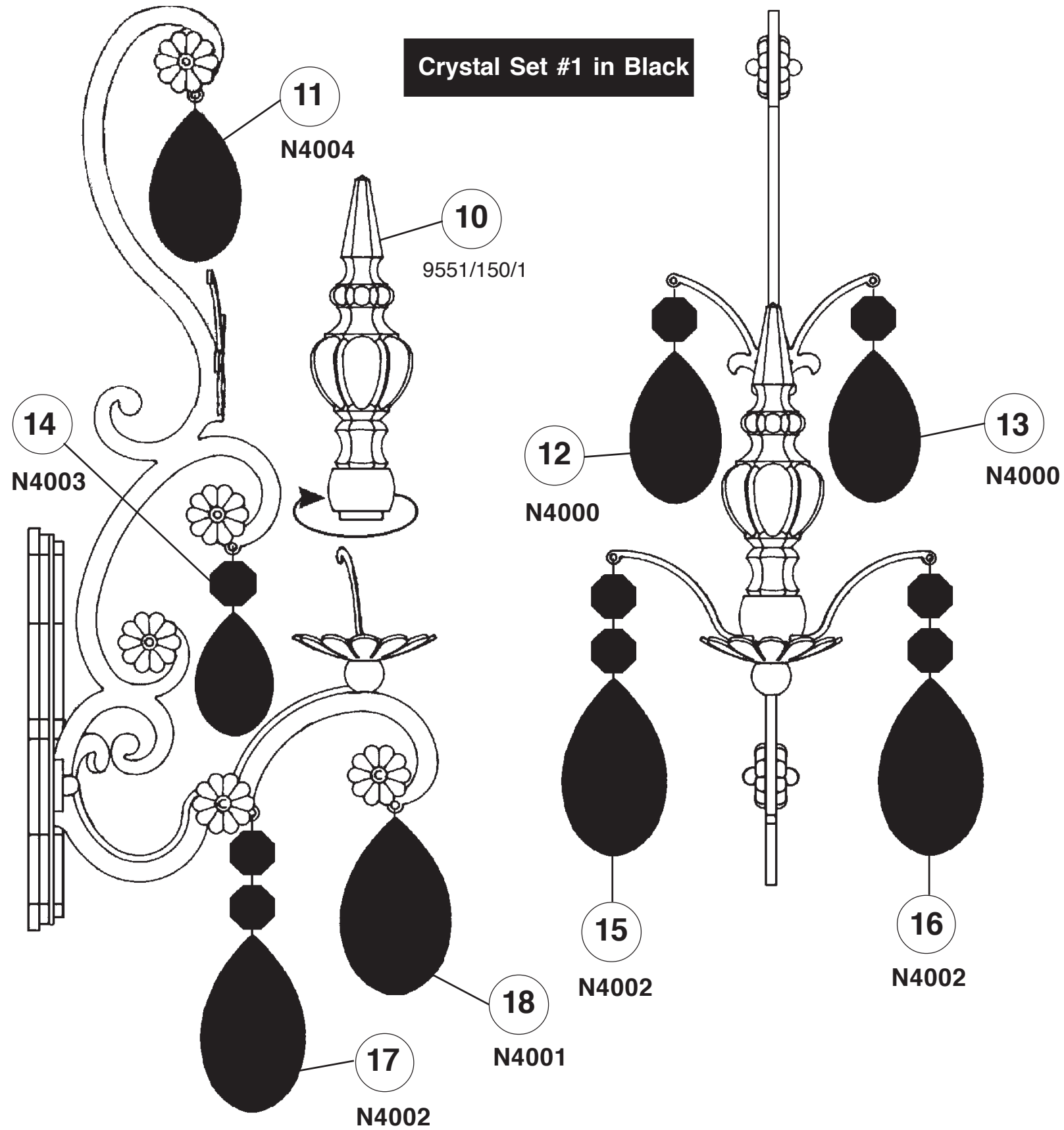

Crystal Set #2 in Black

